

Surface Mount PTC

OZCM Series

0603 Chip
RoHS6 Compliant & Halogen-Free

OZCM Oct2013D

HF (Pb) OZCM Series Fuse

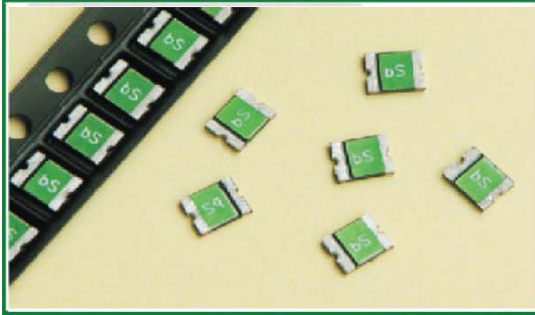

Maximum Voltage

9 - 15V (per table)

Temperature Range

-40°C to 85°C

Agency Approval

TUV (Std. EN60738-1-1, Cert. R50102117)
UL Component (Std. UL1434, File E305051)
UL Conditions of Acceptability:

1. These devices have been investigated for use in safety circuits and are suitable as a limiting device.

2. These devices have been calibrated to limit the current to 8 amps within 5 seconds, per ANSI/NFPA 70, "National Electrical Code"

Application

All high-density boards

Product Features

0603 Chip Size, Fast Trip Time, Low DCR Resistance



Operating (Hold Current) Range

50mA - 200mA

HALOGEN FREE = 

LEAD FREE = 

Electrical Characteristics (23°C)

	Part Number	Hold Current	Trip Current	Max Time to Trip		Maximum Current	Rated Voltage	Typical Power	Resistance Tolerance		Agency Approvals	
		I _H , A	I _T , A	Current	Time				R _{min}	R _{1max}		
A	OZCM0005FF2G	0.05	0.15	0.50	0.10	40	15	0.5	3.80	30.00	Y	Y
B	OZCM0008FF2G	0.08	0.20	0.60	0.10	40	15	0.5	2.80	14.00	Y	Y
C	OZCM0010FF2G	0.10	0.25	0.70	0.10	40	15	0.5	0.90	8.00	Y	Y
D	OZCM0012FF2G	0.12	0.30	0.80	0.10	40	9	0.5	1.10	5.80	Y	Y
E	OZCM0016FF2G	0.16	0.40	1.00	0.10	40	9	0.5	1.00	4.20	Y	Y
F	OZCM0020FF2G	0.20	0.45	2.00	0.10	40	9	0.5	0.55	3.50	Y	Y

I_H Hold Current-maximum current at which the device will not trip in still air at 23°C.I_T Trip current-minimum current at which the device will always trip in still air at 23°C.I_{max} Maximum fault current device can withstand without damage at rated voltage (V_{max}).V_{max} Maximum voltage device can withstand without damage at its rated current.P_d Typical power dissipated by device when in tripped state in 23°C still air environment.R_{min} Minimum device resistance at 23°C.R_{1max} Maximum device resistance at 23°C, 1 hour after initial device trip, or after being soldered to PCB in end application.

Specifications subject to change without notice

Surface Mount PTC

0ZCM Series

0603 Chip
RoHS6 Compliant & Halogen-Free



0ZCM Oct2013C

PTC's – Basic Theory of Operation / "Tripped" Resistance Explanation

Fundamentally, a Bel PTC consists of a block of polymeric material containing conductive filler and bonded between two conductive, planar terminations.

At currents below the device I_{HOLD} rating, AND at temperatures below 100C, the PTC maintains a resistance value below its R_{1 MAX} rating.

As the device's temperature approaches 130C, either due to an increase in ambient temperature or a current exceeding its I_{TRIP} rating, volumetric expansion of the filled polymer breaks apart the majority of conductive pathways across the terminals created by chain contact of adjacent filler particles and device resistance increases sharply by several orders of magnitude.

At the much higher "Tripped" resistance, there is just enough leakage current to allow internal heating to "hold" the device in its tripped state (around 125C) until power is interrupted. Once power is removed, the PTC's core cools and contracts allowing conductive chains to reform and return the device to its low resistance state.

The catalog data for each device specifies a "Typical Power" value. This is the power required to exactly match the heat lost by the tripped device to its ambient surroundings at 23C. By Ohm's Law, power can be stated as: $W = E^2/R$. Thus the approximate resistance of a "Tripped" PTC can be determined by:

$R = E^2/W$, where "E" is the voltage appearing across the PTC (usually the supply's open circuit voltage), and "W" is the Typical Power value for the particular PTC.

Since the PPTC acts to maintain a constant internal temperature, its apparent resistance will change based upon applied voltage and, to a lesser degree, ambient conditions. Consider the following example....

A PTC with a Typical Power of 1 watt protecting a circuit using a 60V supply will demonstrate an apparent, tripped resistance "R" of:

$$R = 60^2/1 = 3,600 \text{ ohms}$$

This same tripped device when used to protect a 12V circuit would now present an apparent resistance of:

$$R = 12^2/1 = 144 \text{ ohms}$$

The value for Typical Power is "typical" because any physical factors that affect heat loss (such as ambient temperature or air convection) will somewhat alter the level of power that the PTC needs to maintain its internal temperature. In short, PTCs do not exhibit a constant, quantifiable tripped resistance value.

Typical Time - To - Trip at 23°C

(See Elec. Characteristics Table for P/N - Curve Correlation)

A BC DE F

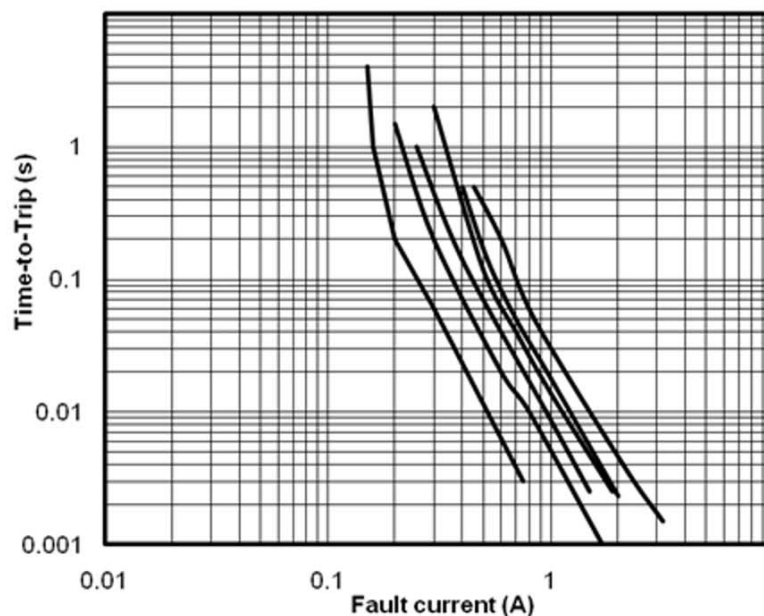

Thermal Derating Curve

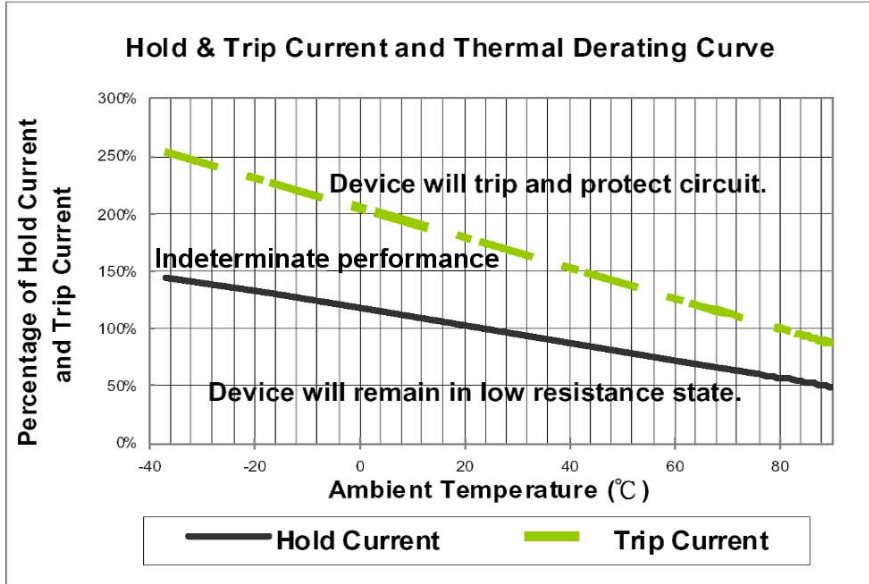

Cautionary Notes

1. Operation beyond the specified maximum ratings or improper use may result in damage and possible electrical arcing and/or flame.
2. These Polymer PTC (PPTC) devices are intended for protection against occasional overcurrent/ overtemperature fault conditions and may not be suitable for use in applications where repeated and/or prolonged fault conditions are anticipated.
3. Avoid contact of PTC device with chemical solvent. Prolonged contact may adversely impact the PTC performance.
4. These PTC devices may not be suitable for use in circuits with a large inductance, as the PTC trip can generate circuit voltage spikes above the PTC rated voltage.
5. These devices are intended for use in DC voltage applications only. Use in AC voltage applications should be first discussed with Bel Fuse engineering
6. Not recommended for use on potted or conformal coated PCB's. Restriction of free air flow could affect electrical performance and/or result in device failure. Consult Bel Fuse engineering.
7. In the "Indeterminate Performance / grey zone", tripping may occur but cannot be relied upon. For special circumstances considering use within this region, consult Bel Fuse Engineering.
8. MSL : 2a (According to IPC J-Std-020).

Mechanical Dimensions

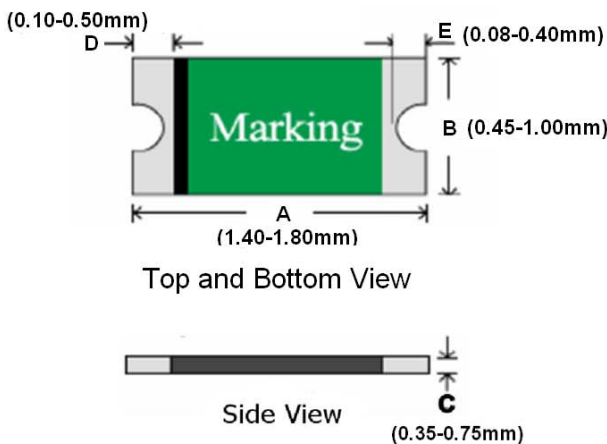

PTC Marking



Part Number	Marking Code
0ZCM0005FF2G	u
0ZCM0008FF2G	x
0ZCM0010FF2G	d
0ZCM0012FF2G	y
0ZCM0016FF2G	z
0ZCM0020FF2G	f

Pad Layout

The dimensions in the table below provide the recommended pad layout.

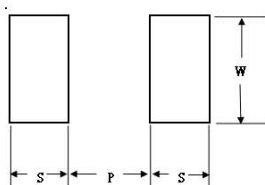

P		S		W	
Nominal		Nominal		Nominal	
mm	Inch	mm	Inch	mm	Inch
0.80	0.031	0.60	0.024	0.80	0.031

Termination Pad Materials

Matte Tin - Plated Copper

Specifications subject to change without notice

Surface Mount PTC

0ZCM Series

0603 Chip
RoHS6 Compliant & Halogen-Free



0ZCM Oct2013D

Solder Reflow and Rework Recommendations

Profile Feature	Pb-Free Assembly
Average Ramp-Up Rate (T _{smax} to T _p)	3 °C/second max.
Preheat :	
Temperature Min (T _{smin})	150 °C
Temperature Max (T _{smax})	200 °C
Time (t _{smin} to t _{smax})	60-180 seconds
Time maintained above:	
Temperature (T _L)	217 °C
Time (t _L)	60-150 seconds
Peak/Classification Temperature (T_p) :	260 °C
Time within 5°C of actual Peak :	
Temperature (t _p)	20-40 seconds
Ramp-Down Rate :	6 °C/second max.
Time 25 °C to Peak Temperature :	8 minutes max.

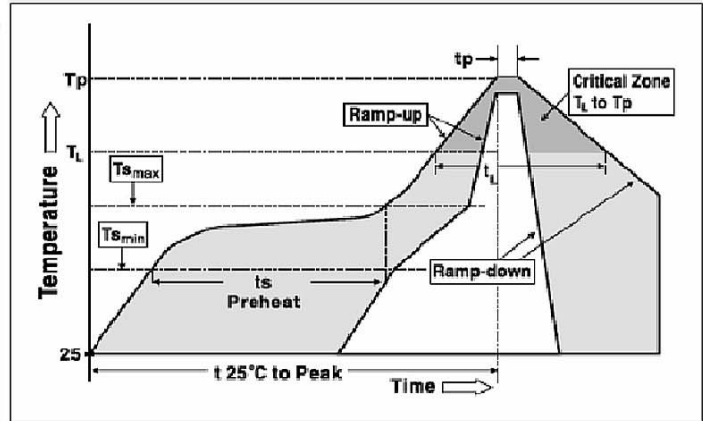

Solder Reflow

Due to "lead free / RoHS6" construction of these PTC devices, the required Temperature and Dwell Time in the "Soldering" zone of the reflow profile are greater than those used for non-RoHS devices.

1. Recommended reflow methods ; IR , vapor phase oven , hot air oven.
2. Not Recommended For Wave Solder / Direct Immersion.
3. Recommended maximum ; paste thickness is 0.25mm.
4. Devices are compatible with standard industry cleaning solvents and methods.

Caution

If reflow temperature / dwell times exceed the recommended profile, the electrical performance of the PTC may be affected.

Rework : MIL-STD-202G Method 210F. Test Condition A.

Standard Packaging

Part Number	Tape/Reel Qty
0ZCM0005FF2G	4,000
0ZCM0008FF2G	
0ZCM0010FF2G	
0ZCM0012FF2G	
0ZCM0016FF2G	
0ZCM0020FF2G	

4000 fuses in 7 inches dia. Reel, 8mm wide tape, 4mm pitch, per EIA-481 (equivalent IEC-286 part 3).

P/N Explanation and Ordering Information

	0ZCM	0XXX	X	X	XX
PTC series	0ZCM, 0603 Size				
I HOLD Rating	Refer to Part Number and IH Rating in Electrical Characteristics Table on P.1.				
Electric Characteristics	F = Standard Design A to Z (except F) = Special, customer spec, DCR sort, etc.				
Mechanical Features	F = Standard Design A to Z (except F) = Special, customer spec, lead forming, etc.				
Tape & Reel Qty	See standard packaging				

Specifications subject to change without notice

CORPORATE OFFICE

Bel Fuse Inc.
206 Van Vorst Street
Jersey City, NJ 07302
Tel 201-432-0463
Fax 201-432-9542
E-Mail: belfuse@belf.com
Website: www. belfuse.com

FAR EAST OFFICE

Bel Fuse Ltd.
8/F Luk Hop Industrial Building
8 Luk Hop Street
San Po Kong
Kowloon, Hong Kong
Tel 852-2328-5515
Fax 852-2352-3706

EUROPE OFFICE

Bel Fuse Europe Ltd.
Preston Technology Management Centre
Marsh Lane, Suite F15
Preston, Lancashire, PR1 8UQ
United Kingdom
Tel 44-1772-556601
Fax 44-1772-561008

EUROPE

Bel Stewart GmbH
Industriestrasse 20
61381 Friedrichsdorf
Germany
Tel 49-6172-9552-0
Fax 49-6172-9552-40